



# Warehouse Safety Manual

Operation, use, review and maintenance of Live pallet racking facilities and the Push-back system



# Summary

MANUAL FOR USING AND MAINTAINING THE LIVE PALLET RACKS  
AND THE PUSH-BACK SYSTEM

---

<b>3</b>	<b>Introduction</b>
<b>4</b>	<b>Key warehouse components</b>
4	Load units
5	Slabs or floors
6	Lifting equipment
7	Storage systems
<b>8</b>	<b>Live pallet racks</b>
<b>10</b>	<b>Pallet racks for a Push-back system</b>
<b>13</b>	<b>Using the equipment and racking units</b>
13	Load units
15	Forklifts
19	Live pallet racks
23	Pallet racking for a Push-back system
<b>26</b>	<b>Review and maintenance</b>
26	Inspecting the storage system
28	Maintenance guidelines
28	Inspecting the frames
30	Inspecting the racking units
31	Inspecting the crossbeams
31	Inspecting the safety pins, rollers and carriages
33	Assembly tolerances
34	Inspecting the floors and aisles
35	Inspecting the load units
37	Inspecting the lifting equipment
38	Other considerations
39	Evaluation checklist

# Introduction

It is becoming more common to apply the concepts of productivity and working conditions to warehouses. This is why safety standards must become stricter and more rigorously applied to handling procedures related to racking units. This will in turn help prevent the personnel in charge of executing any of these tasks from being exposed to any danger.

This manual covers all warehouses where load units, generally pallets or containers, are handled by either forklifts or other lifting equipment, which means we can exclude any risks derived by any manual loading that takes place in these types of warehouses.

The proper condition of a pallet warehouse helps facilitate the work carried out inside them. However, the improper use of any of the components forming part of this warehouse may result in accidents.

The basic component we find in a warehouse include:

- The slab or floor.
- Load units.
- Lifting equipment.
- Racking.

With the aim of avoiding situations that may imply the risk of injury to warehouse personnel, costly service interruption or damage to the facility or merchandise, the following measures are highly recommended:

- **Prevention:** training all personnel on properly using the facility and equipment.
- **Inspection:** ongoing checks by personnel to ensure that all operating conditions are optimal and being complied with.
- **Maintenance:** when any imperfection or malfunction arises in any area of the warehouse, it is immediately attended to and corrected.

A facility is used safely and rationally through the collaboration between the user and the manufacturers of the racking units and lifting equipment.

The Mecalux Group has prepared this manual with the purpose of guiding its customers through the proper use of its racking units. When drafted, several recommendations derived from European bodies (FEM, INRS) in the sector were strictly taken into account: European standard EN15635 "Steel Static Storage Systems - Adjustable Pallet Racking. Guidelines for Safe Use", plus the company's over 50 years' experience in the warehouse sector.

Consequently, this manual should be read carefully and its recommendations strictly applied. The Mecalux Group is available for any consultation on the material that the user may find worthwhile for their facility.

## Important Note!

The responsibility for the security, use and condition of the facility rests with the customer, who must transmit the contents of this manual to those in charge of the warehouse and its users.

This manual has been prepared in compliance with EN standard 15635.

Users must also comply with the specific regulations in each country for this type of facilities.

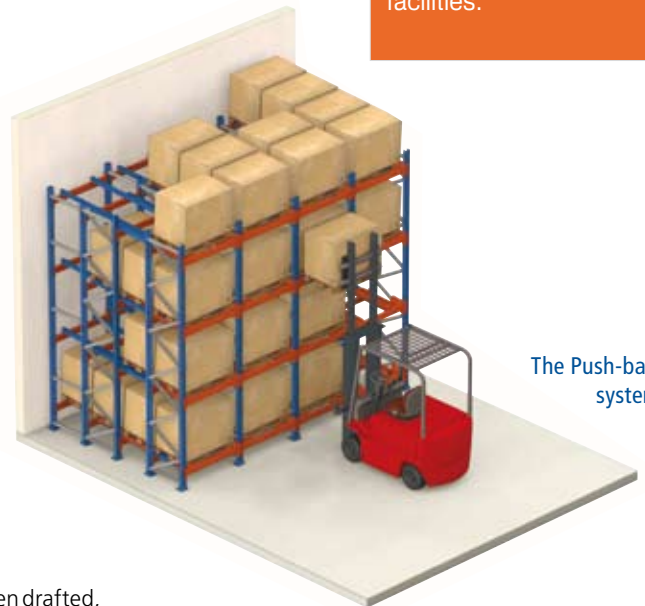

The Push-back system.

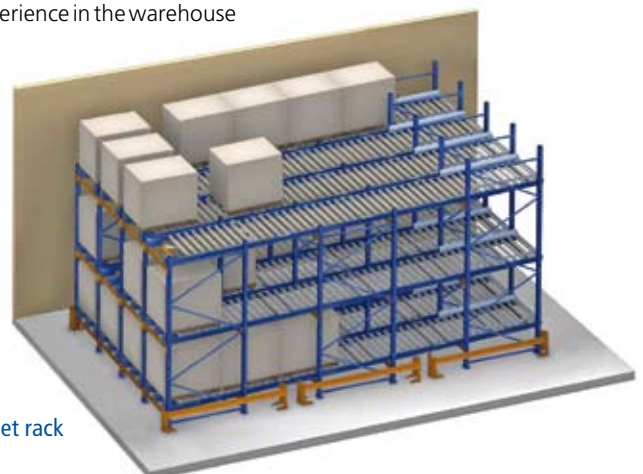

Live pallet rack



---

## Key warehouse components

### Load units

The load units are determined by the product to be stored and any additional elements that we require to move and store this product (pallets and crates).

There are pallets made of different materials and different platforms:

- Wooden pallets
- Metal or plastic pallets

The construction of these platforms must comply with the following requirements:

- Specifications found in ISO, EN and UNE standards.
- The ability to support the deposited load.
- Appropriateness to the model planned for the facility's original design.

In order to store plastic or metal load units or containers, special considerations must be taken into account. These considerations must be precisely defined and established before the design has been made. It is likely that the additional measures necessary will require a greater maintenance effort at the facility.

Wooden pallet.



Metal or plastic pallet.



Both the weight and maximum dimensions of the pallet load units have to be predefined. The system can then be properly operated in terms of resistance and clearance. The load units can take on different shapes once the merchandise has been placed on the pallet.

The same size as the pallet and aligned with it.



Larger than the pallet, but centred over it.



Fanned.



Bowed.



## Slab or floor

This is a basic structural component in the operation of the warehouse, whose definition and construction strictly considered as to:

- Characteristics such as stability and resistance, which must be able to resist the loads transmitted by the racking units and the lifting equipment. As a minimum, concrete must be C20/25 (according to EN 1992) with a minimum resistance of 20 N/mm<sup>2</sup>.
- The horizontal alignment or levelling of the slab or floor, which must be done according the specifications found in EN standard 15620.

Slabs or floors can have several finishes (concrete, bituminous materials, etc.). When using bituminous materials, special attention must be paid to the design of the racking units.

The thickness and geometrical features of the slab or floor must be well suited for installing the anchor bolts on the racking unit bases.

## Lifting equipment

This is mechanical or electromechanical equipment not only used for lifting merchandise in loading and unloading operations in storage systems but also transporting it from place to place.

Here we can see the most common ones used for racking units:

- **Stacker.** Driver sits on board or at floor level.
- **Counterbalance forklift.** With three or four wheels.
- **Reach trucks.** Counterbalanced a retracting mast.
- **Extended forklift.** Divided into turret trucks, side loaders and order-pickers.
- **Multi-directional forklifts** or four-wheel steered trucks.
- **Hoists.** For automatic facilities.



Stacker



Counterbalance forklift



Hoist



Reach truck



Turret truck



Side Loader

Choosing these tools is the key to properly handling a pallet warehouse. To do so, the following information must be closely considered:

- sizes,
- manoeuvring aisle needed,
- maximum lifting height,
- maximum lifting load.

The capacity of a warehouse depends in great measure on these factors, especially the manoeuvring aisle and lifting height.

The machine must have a load capacity that is perfectly suited to the load unit.

The size of the forks or the implements and accessories must be suited to the load unit.

## Storage systems

Here we explain the nomenclature used to refer to the parts that form the racking unit or storage system.

A storage system is a structural set of metal racks designed to store loading units in a safe and organised fashion

According to EN standard 15620, and in accordance with the lifting equipment being utilised, storage systems can be classified in the following manner:

- **Class 100:** pallet loaded racking units with a narrow aisle operated by automatically controlled hoists.
- **Class 200:** pallet loaded racking units with a narrow aisle operated by automatically controlled hoists with additional positioning.
- **Class 300:** pallet loaded racking units with a narrow aisle operated only by forklifts that do not have to turn in the aisle in order to load or offload load units onto or from the racking unit. Forklifts are driven the length of the aisle along mechanical guide rails or induction cables.

**Class 300A:** The operator raises and lowers together with the load unit and uses manual height positioning. When the operator remains at ground level, there is a closed-circuit camera display or equivalent system.

**Class 300B:** The operator always remains at ground level and does not have indirect vision systems.

- **Class 400**

With wide aisles: pallet loaded racking units with aisles wide enough to permit the forklift to turn 90° when carrying out loading and unloading operations to the racking units. With narrow aisles: pallet loaded racking unit with a narrow aisle that can be used by specialized forklifts.

This safety manual only deals with live pallet racking units using gravity and the Push-back system

Its design was determined from data or specifications provided by the user or representative. To be specific, the characteristics to be considered for live pallet systems using gravity or a Push-back system are comprised in EN standard 15269 "Steel Static Storage Systems - Adjustable Pallet Racking. Guidelines for Specifications". Nevertheless, the principle data for any storage system are:

- Load units.
- Location of the facility.
- Lifting equipment used.
- Locale or space being occupied.
- Characteristics of the slab or floor.
- Intended use of the warehouse.

By defining what the characteristics are, Mecalux can design the best storage system that suits each, always keeping the instructions provided by the future user in mind. All these specifications will be reflected in the technical memory of the proposal and the load placard placed at the entrance to the facility.

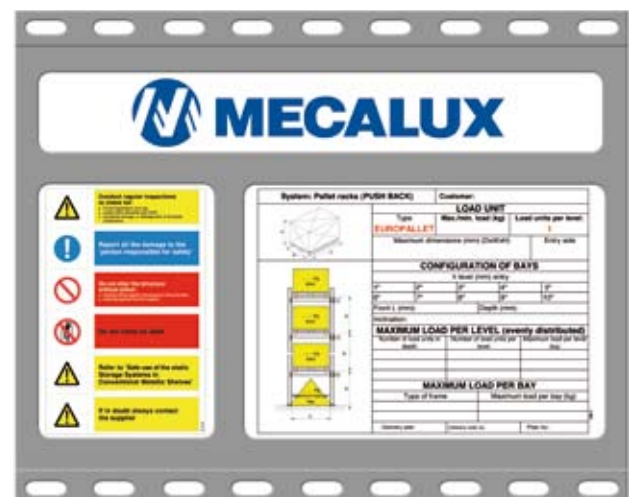
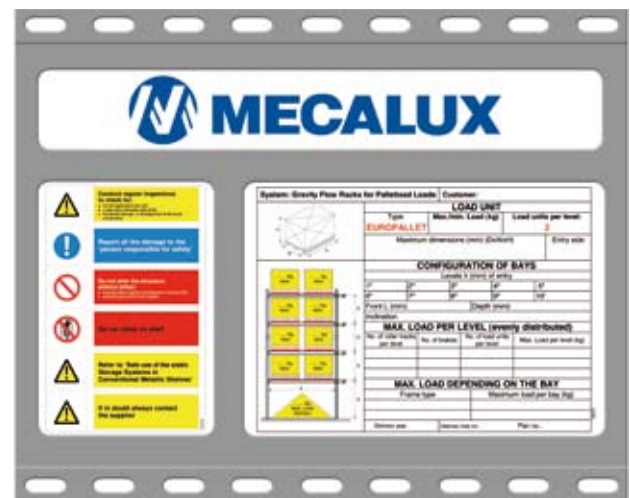

### Important Note!

Any change, modification or expansion of the facility will require the study and authorization of the Mecalux Group.

## Live pallet racking

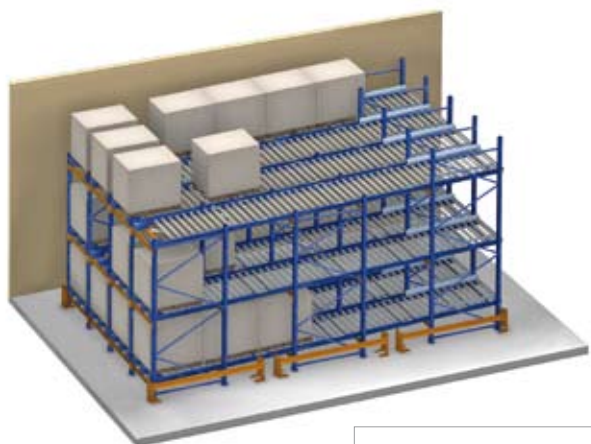

In live pallet racking units, the load levels are formed by rollers installed upon a gentle slope which allows the pallets to slide forward. The pallets enter from the highest part of the rack and slide via gravity at a controlled speed until they reach the opposite end, accumulating one behind one another in such a way that they are readily available to the user. When the first stored pallet is removed, the one behind it takes its place.

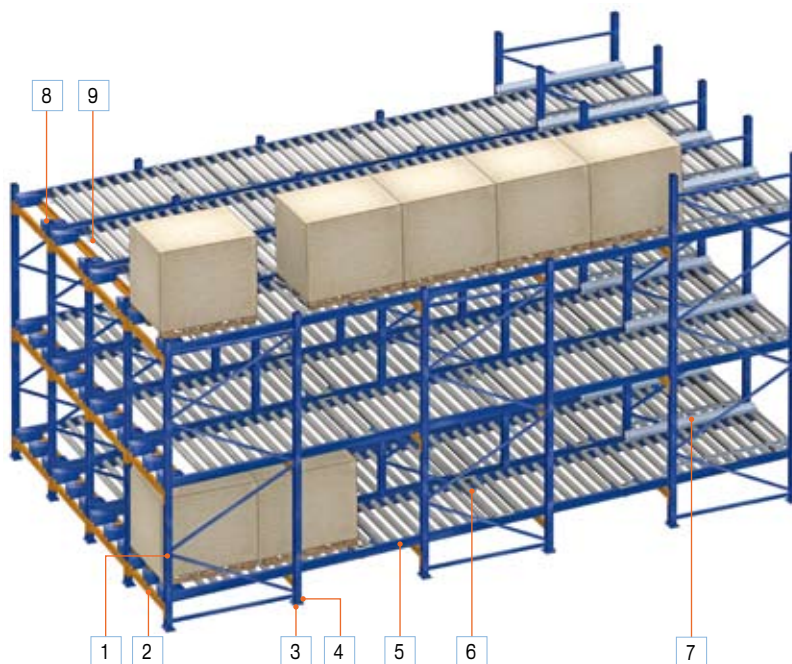
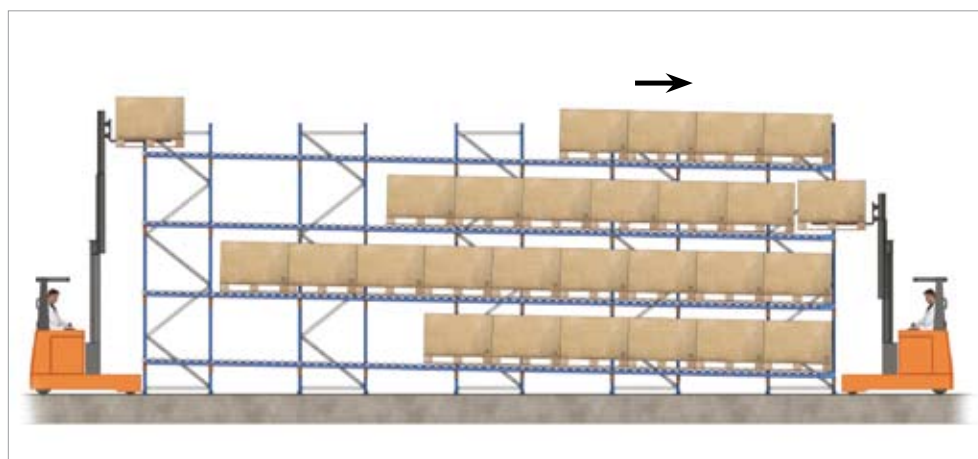

### Structure

- 1) Frames
- 2) Crossbeams
- 3) Levelling shims
- 4) Anchor bolts

### Roller tracks

- 5) Tracks
- 6) Rollers
- 7) Pallet centres
- 8) Braking ramps
- 9) Pallet retainer/spacer (optional)

Your facility may only include some of the elements mentioned above.

The delivered plans and offers template shows the construction system installed in your warehouse.



## Description

The basic components of a live facility are:

- **Frames:** vertical metal components to support the different load levels.
- **Crossbeams:** horizontal metal components fastened to the posts which indirectly support the loading units on each level and on which the roller track are lain.
- **Rollers:** the characteristics of the roller components ensure pallets slide smoothly over them. They have flattened axes which fit into the grooves of the track. The separation between them and their diameters depend on the characteristics and weight of the pallets being used.
- **Roller tracks:** horizontal metal components composed of side sections with perpendicular rollers. On each level they are installed perpendicularly to the operating aisles and the load units slide down the tracks at a speed controlled by the brake drums or the braking rollers.

Other optional components:

- **Pallet centring devices:** these centre the pallets at the entrance of the aisle.
- **Brake ramps:** these brake and retain the pallets at the exit. They are aligned with the bottom skids of the pallets.
- **Roller guards:** these protect the first roller at the entrance from head-on collisions.
- **Pallet retainers:** these retain or separate the pallets, making it easier to extract the first one by distributing the pressure exerted between them. They include a set of parts which continue retaining the pallets when the first one is being removed or just slightly raised.

The installation of these items is optional and they depend on the characteristics of the facility itself and the type of forklift or storage machinery being used.

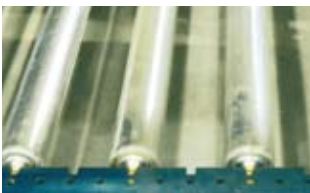

Rollers



Brake drums



Brake rollers



Pallet centring device



Roller guards



Pallet retainers



Brake ramps



Brake stopper

The pressure the first pallet exerts on the pedal activates the tabs that retain the second pallet.

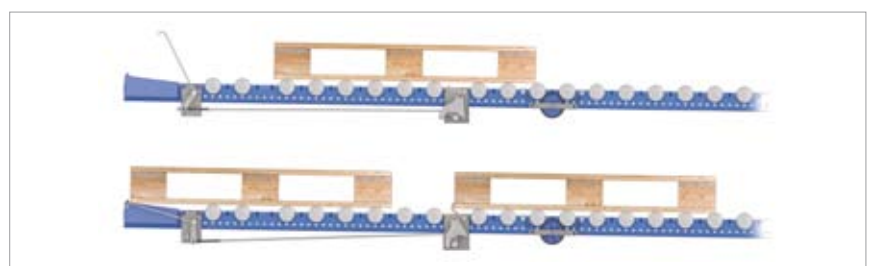

## Pallet racking for the Push-back system

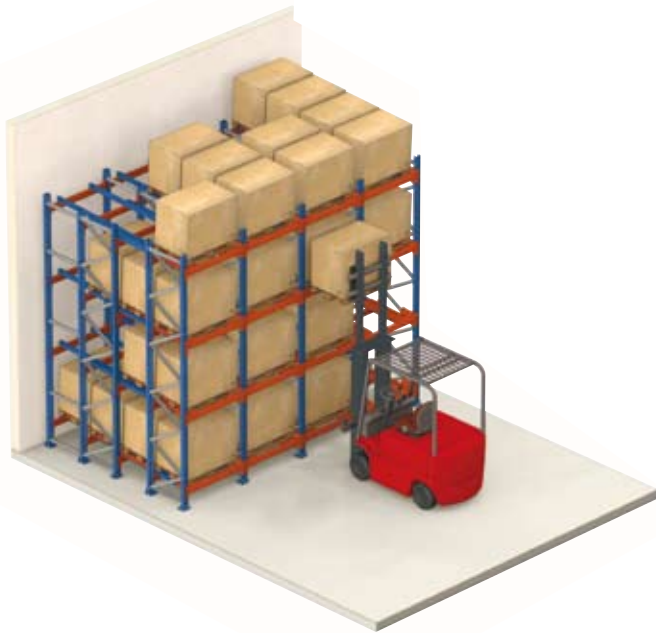

The Push-back racking system is a storage stacking system that can store up to four pallets per level.

All the pallets on each level, except the last one, are placed on top of a set of carriages which slide over roller tracks when pushed. These tracks are mounted over a slight inclination with the front being lower, allowing the back pallets to move forward when the aisle-side pallet is removed.

The pallets placed on each level must be the same reference item and are handled according LIFO procedures (last one in, first one out).

These racking units function in the following way:

- Each rack level has two or three parallel carriages set at different heights.
- The forklift deposits the first pallet on the highest set of parallel carriages.
- With the second pallet ready for storage, the forklift pushes the first pallet until it uncovers the second set of carriages and places the pallet on top of them.
- If the facility has been outfitted to store four pallets, the operation is repeated for the third pallet, with the last one resting directly on the roller track, not the carriages.
- To remove the pallets, the operation is done in reverse, so when the first pallet is removed, the rest slide towards the aisle into position.



- 1) Frame
- 2) PB front crossbeam
- 3) PB middle crossbeam
- 4) PB end crossbeam
- 5) Track
- 6) PB carriage
- 7) Supplement plates
- 8) Anchor Bolts

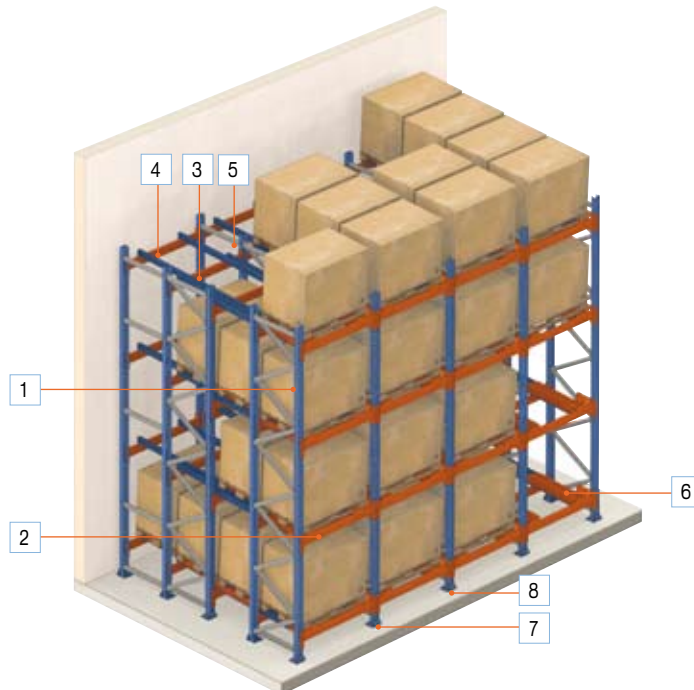

### Description

The basic components of a Push-Back installation are:

- **Frames:** vertical metal components to support the different load levels.
- **Crossbeams:** horizontal metal components where the load is deposited on.
- **Tracks:** the roller track and the carriage are supported on the rack's crossbeams. They are mounted over an appropriate slope so the carriages can slide forward correctly.



The levels are built to store one or two storage channels.



Track (5) and PB track support (7)

The «I»-shape of the track allows the rolling components to be housed on both sides of the core, thus ensuring proper sliding and preventing any possible derailment.

- **PB carriages / PB safeties:** each carriage, in addition to its rolling components, has a safety catch that keeps it from sliding if the pallet has not been properly set down.



PB carriage (6) and PB safety.

Carriage gauge (9)

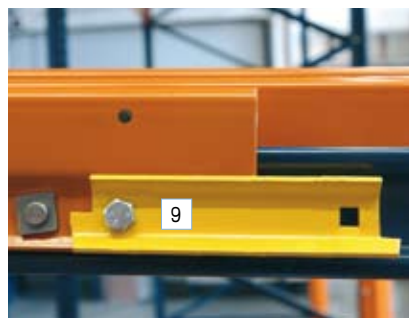

The front crossbeams have supports and fasteners, in addition to bumpers and drill holes, which allow a gauge to stick out that indicates the presence of an available carriage, primarily needed for higher levels.



## Using the equipment and racking units

### Load units

The load unit, formed by the pallet or container plus the merchandise, must adhere to the following requirements:

- Adjustable to the size considered in the racking unit design, meaning it must not surpass either the maximum defined weight or size (front, depth and height).
- The pallet or container must correspond what the design has established and not present any type of damage or wear.

Non-conforming load units are those presenting damage or wear, as defined in the section on "Checking the Load Units" in this manual. A control system must be established to prevent to the recirculation of damaged pallets in the warehouse.

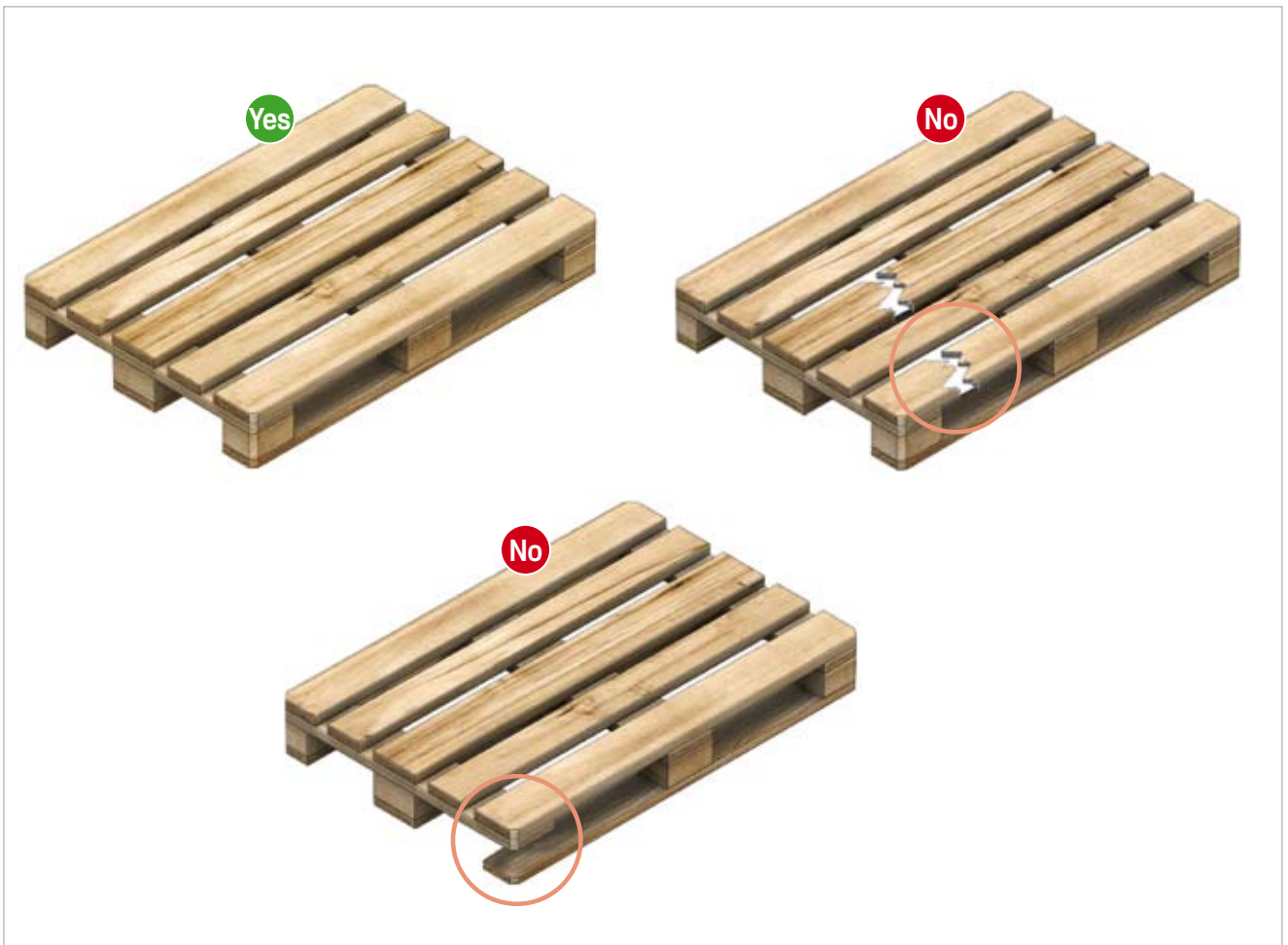

## Using the equipment and racking units

- The entire unit must be stable and compact due to its proper distribution with the merchandise being fastened or tied down via straps, shrink-wrapping...
- The merchandise must be uniformly distributed on the pallet.

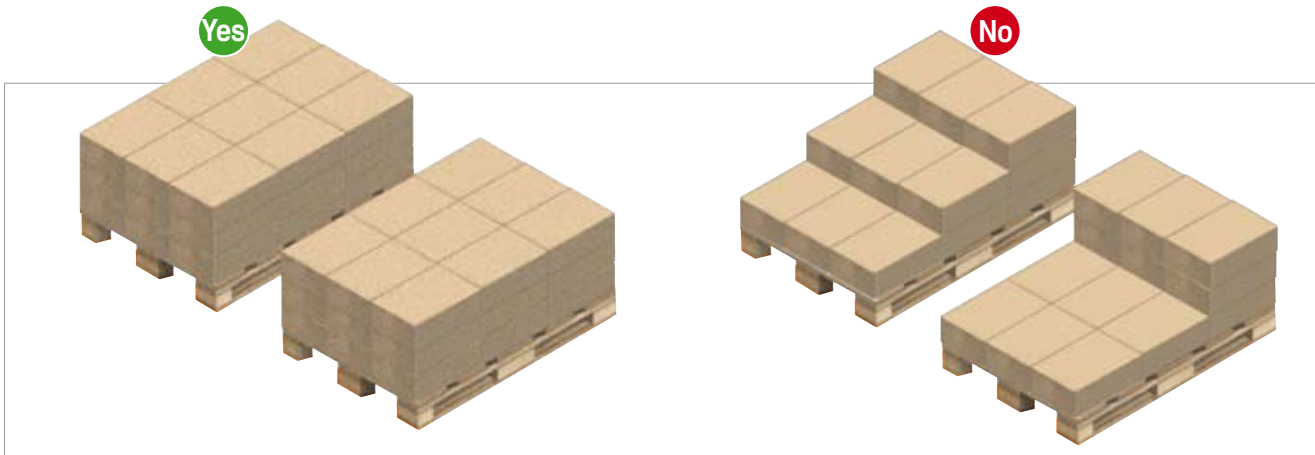

- The merchandise must be correctly stacked on the pallet.



Standardised pallets adhere to the stipulations in their corresponding regulations:

- **EN 13382**

Pallets for handling merchandise. Principal dimensions.

- **EN 13698-1**

Specification for pallet production Part 1: specifications for building 800x1200 mm flat wooden pallets.

- **EN 13698-2**

Specifications for producing pallets. Part 2: specifications for building 1000x1200 mm flat wooden pallets.

### Very important!

In order to ensure that the two storage solutions described in this manual work properly it is essential that all pallets are in a good state and adhere to the quality standards described in regulations.

## Forklifts

### Safe driving

- The forklift operator must be specially trained.
- The forklift must be appropriate for the load and area where it is being operated.
- Extreme prudence must be taken when turning.
- Avoid making turns on ramps or slopes.
- Do not use the forklift as a means of transporting personnel.
- Maintain a minimum distance between forklifts equivalent to the sum of three forklifts.
- Always respect the specific handling regulations for each company.
- Pay close attention to where and how the forklift is parked when not in use.
- Always face the direction the forklift is moving.
- While driving, avoid:
  - Excessive velocity
  - Abrupt movements
  - Improperly placed loads.

### Load requirements

- Loads with or without pallets must adhere to the minimum requirements that make it:
  - Capable of being handled by forks or the proper tools.
  - Stable enough to keep together during all handling and transport operations.
  - Resistant to the physical demands handling requires.
- Able to be transported between 15 and 20 cm from the floor.
- If the volume of the load impedes driver visibility, the forklift must be operated in reverse gear.
- Pay special attention while transporting and depositing cylindrical loads such as pipes or trunks as they can slide off the forklift.
- Do not take unnecessary risks when the weight distribution of a particular load is undetermined. Act prudently.
- Do not cover the safety cabin, as there will be a loss of visibility.



### Load - forklift interaction

- The forklift is similar to balanced scale, but it is possible to lose balance longitudinally by overloading it, situating the load incorrectly, or positioning it at the wrong height.
 

Consequences: tipping towards the front, a loss of steering, damage to the load being handled, etc.
- Transversal balance can be lost when carrying an off-centre load, turning at an excessive velocity or turning while the load is positioned at an improper height.
 

Consequences: tipping the forklift over on its side (a serious or deadly accident), damage to the load being handled, etc.

### Moving a load

The centre of gravity of the entire load must be kept as low as possible, which is why loads are carried on the lowest fork level around 15-20 cm from the floor, thus having plenty of visibility by limiting the size and height of the load. The maximum height of the load must be less than the height of the fork holder. If it is necessary to carry loads higher than that of the mast, first check whether this must be joined or tied to the rest of the load. Transporting loads is always done using both forks, where the load is always distributed evenly to ensure stability.

Never travel or leave the forklift parked with the forks raised (figure 1).

Always face the direction the forklift is moving.

Loads must be carried while fastened accordingly with bands, straps, shrink-wrapping, brackets, etc. Any loose material must go into containers.

In cases where visibility is difficult due to the volume of the load, use the reverse gear to transport it (figure 2).

On slopes or ramps, drive forward going up and reverse going down, so the mast is always inclined backward in a straight line (figure 3).



**Figure 1**  
Do not transport with the load raised.



**Figure 2**  
Moving bulky loads.

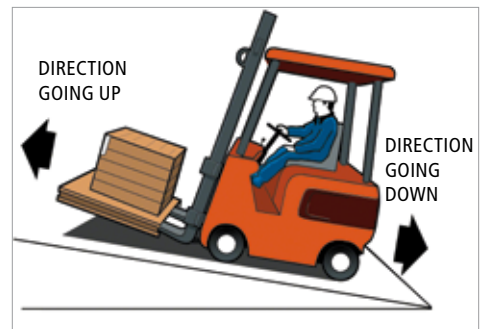

**Figure 3**  
Driving on slopes.

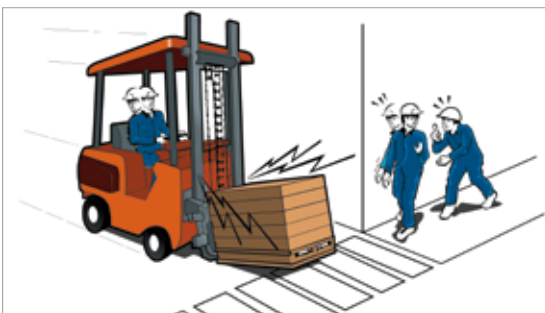

**Figure 4**  
Slow down at intersections.

If there is a lack of visibility due to meteorological or environmental conditions, such as darkness, use all available lights.

At intersections without proper visibility, use the horn to warn nearby personnel, always facing the direction the forklift is moving. At intersections and foot traffic lanes, any forklifts or pedestrians who may be travelling will have the right of way. If a forklift is executing certain manoeuvres (loading, unloading, lifting, etc) in these traffic areas, pedestrians must wait until they have finished their tasks before continuing on their way (figure 4).



Pay special attention when driving in reverse in narrow areas with stationary objects. Avoid driving excessively fast and making abrupt movements (figure 5).

When two forklifts are travelling in the same direction, a minimum distance equivalent to the sum of three forklifts, including their loads, must be kept between them (figure 6).

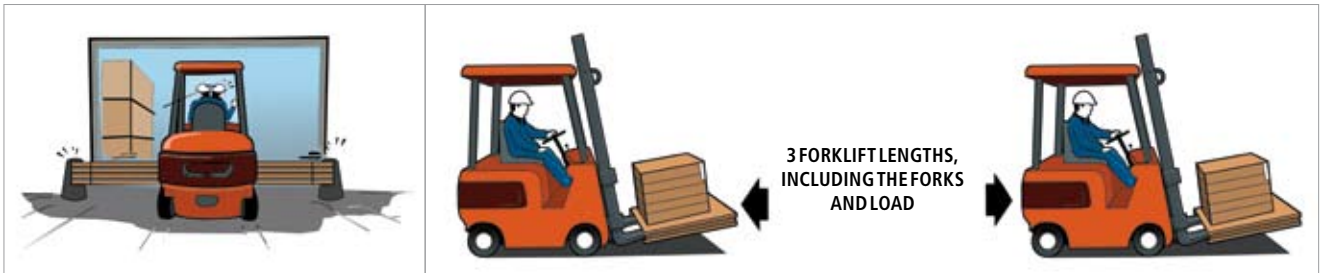

**Figure 5**  
Pay attention to the facility's size limits.

**Figure 6**  
The proper distance between two forklifts.

Respect all rules and traffic signs. The maximum speed established at work centres is 10 km/h, which is a brisk walking speed (figure 7).

Ramps to cover small differences in floor height must be fastened to the floor to keep them from sliding.

The operator's entire body must always be kept inside the vehicle (the safety cabin). At no time may drivers operate the vehicle with their legs or arms hanging outside.

Verify the quality and resistance of the floor being travelled on and check whether it can support the weight of the forklift and load.

If the forklift drips oil, its motor overheats, or brakes slip, etc., it must be parked in an area which does not interfere with personnel, equipment or the work in process. These circumstances must be reported to the immediate superior.

If while transporting loads or carrying out operations an emergency occurs and the forklift goes out of control (figure 8):

- Do not jump out.
- Hold the wheel firmly.
- Press your feet firmly to the floor
- Lean in the opposite direction to the impact.



**Figure 7**  
Work centre speed limit.

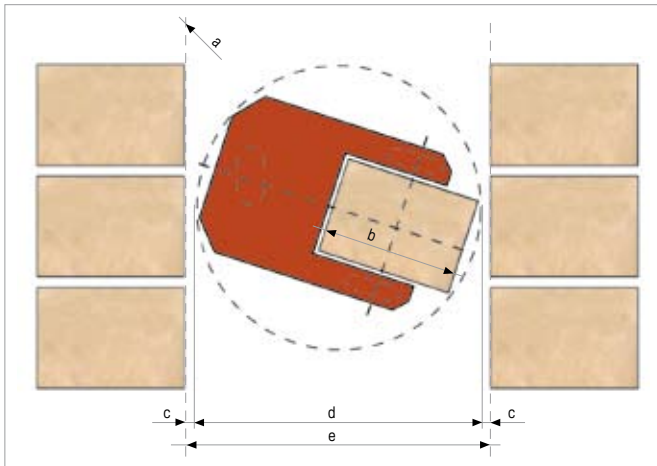

**Figure 8**  
Losing control of the forklift.

### Loading/unloading operations

The structure forming the conventional racking unit is calculated to work under normal service conditions (static loads). These conditions will not be complied with if forklift operations cause collisions, use pulling or pushing movements, places load abruptly, etc.

Therefore, in addition to properly training staff in the use of forklifts (which implies the prevention of accidents), the following aspects in particular must be considered:



- a) Maximum line of outward-facing pallets.
- b) Maximum dimensions of pallet and load.
- c) Clearance.
- d) Forklift and load turning diameter.
- e) Open aisle area between loaded pallets.

- The aisle between loads (e) must allow for a proper turn without the forklift and load colliding into it (d), because there is the necessary clearance (c).
- The speed used to while moving, approaching and removing the load from the rack must be appropriate and adjusted to the nature of the load unit.
- The forklift must move vertically toward the gap and be positioned frontally with the load slightly raised from the floor.

## Live pallet racking

Live pallet racks are exclusively designed to insert pallets at the rear (the highest part) and extract them from their front (the lowest part).

The factors to bear in mind when using a live pallet storage system include:

### Factor 1. Established design

The established design must not be varied in any shape or form (load units, geometry...) without consulting Mecalux technical departments.

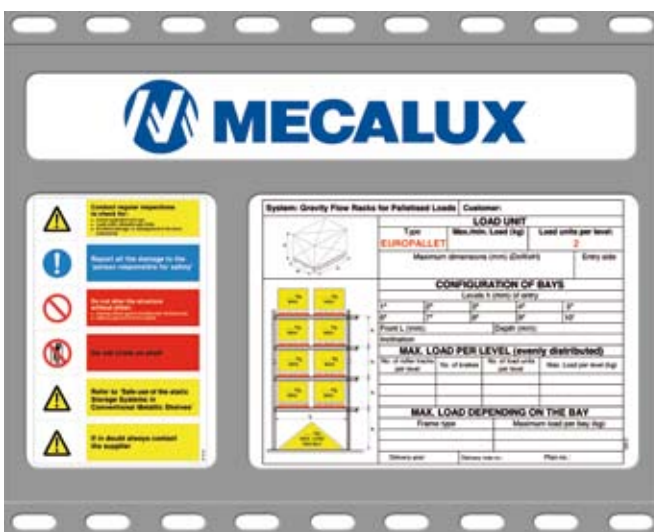

It is expressly prohibited to:

- Modify the height of the levels.
- Modify the number of levels (even when maintaining the load per frame).
- Modify the bars.
- Remove or add levels.
- Use the facility in such a way that damages its principal components (frames, crossbeams, safety catches, braces...).
- Use the facility without its components (frames, crossbeams, safety catches, braces...).
- Use the facility when the frame is out of alignment.

### Important Note!

The facility characteristics are reflected on the technical notes from the Mecalux proposal and the load placard placed at the entrance to the facility.

### Factor 2. Placing the load units

On a live pallet system, pallets must be handled in such a way that the bottom skids are supported perpendicularly over the rollers, which allows the load to slide.

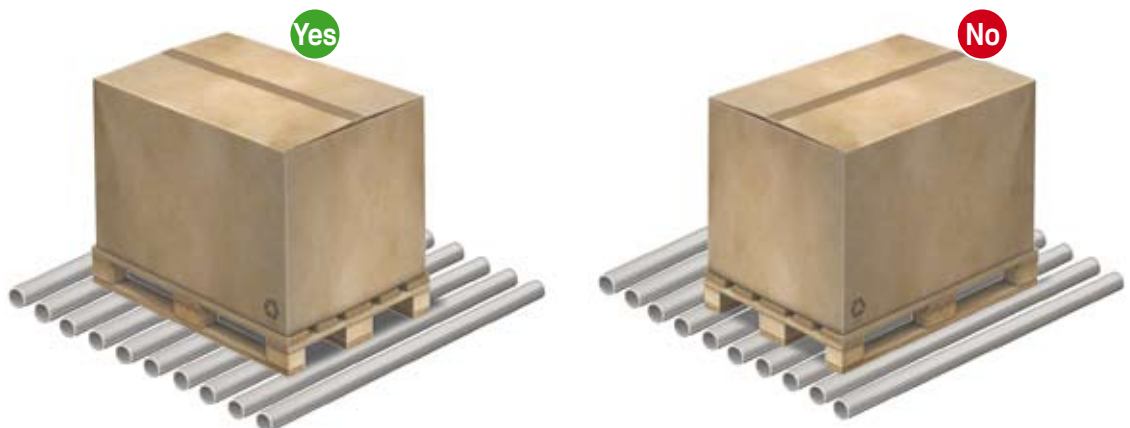

**Factor 3. Abiding by clearance margins**

Front tolerance (in mm)								
A	B	C (1)	D (1)	E	F	G	H	I
800	115	880	75	50	65	900	1,030	400
1,000	115	1,080	75	50	65	1,100	1,230	400
1,200	115	1,280	75	50	65	1,300	1,430	400

(1) Maximum load overflow and minimum tolerance.

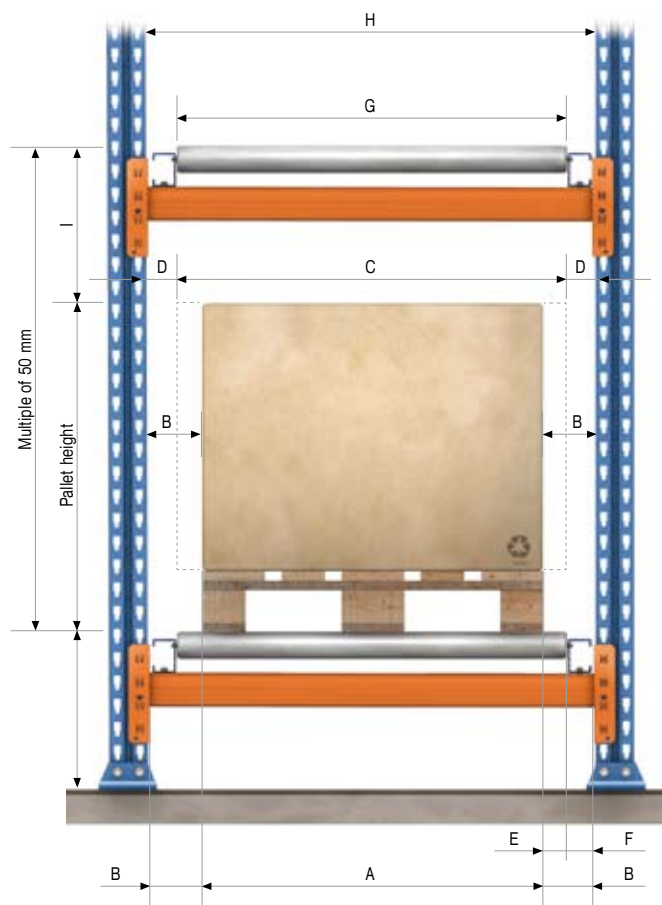

The clearances allowed in a live pallet racking facility depends on the size of the pallets, the depth of the facility, the lifting machinery used, etc.

The most common tolerance levels are reflected in this section.



**Factor 4. Loading methods**

The pallets must be loaded into the central position. To do this the pallet centres must be in good condition and avoid hitting them.

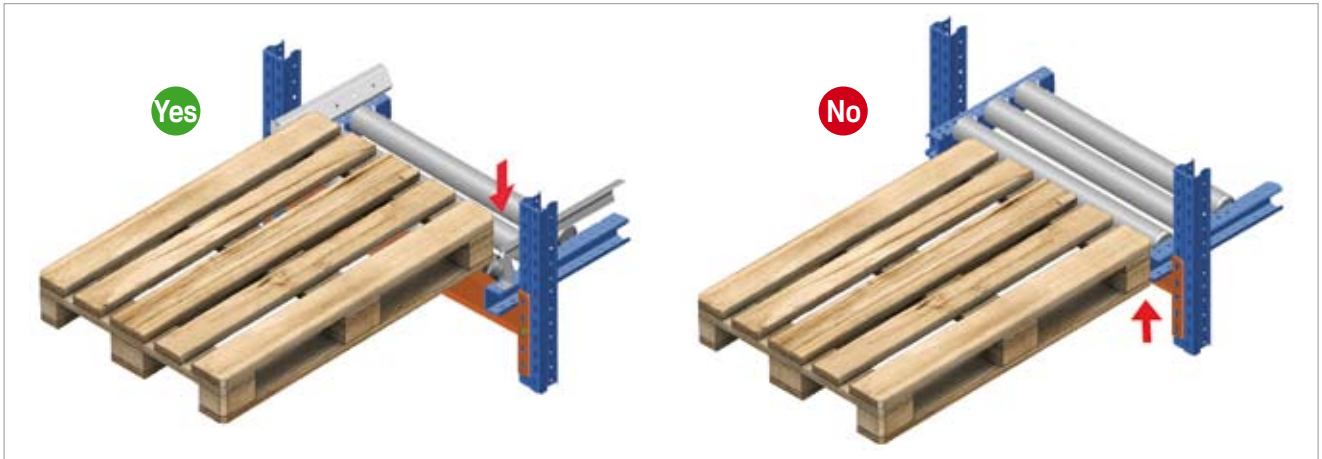

The load must be raised when inserting it, enough to prevent hitting the roller guard.

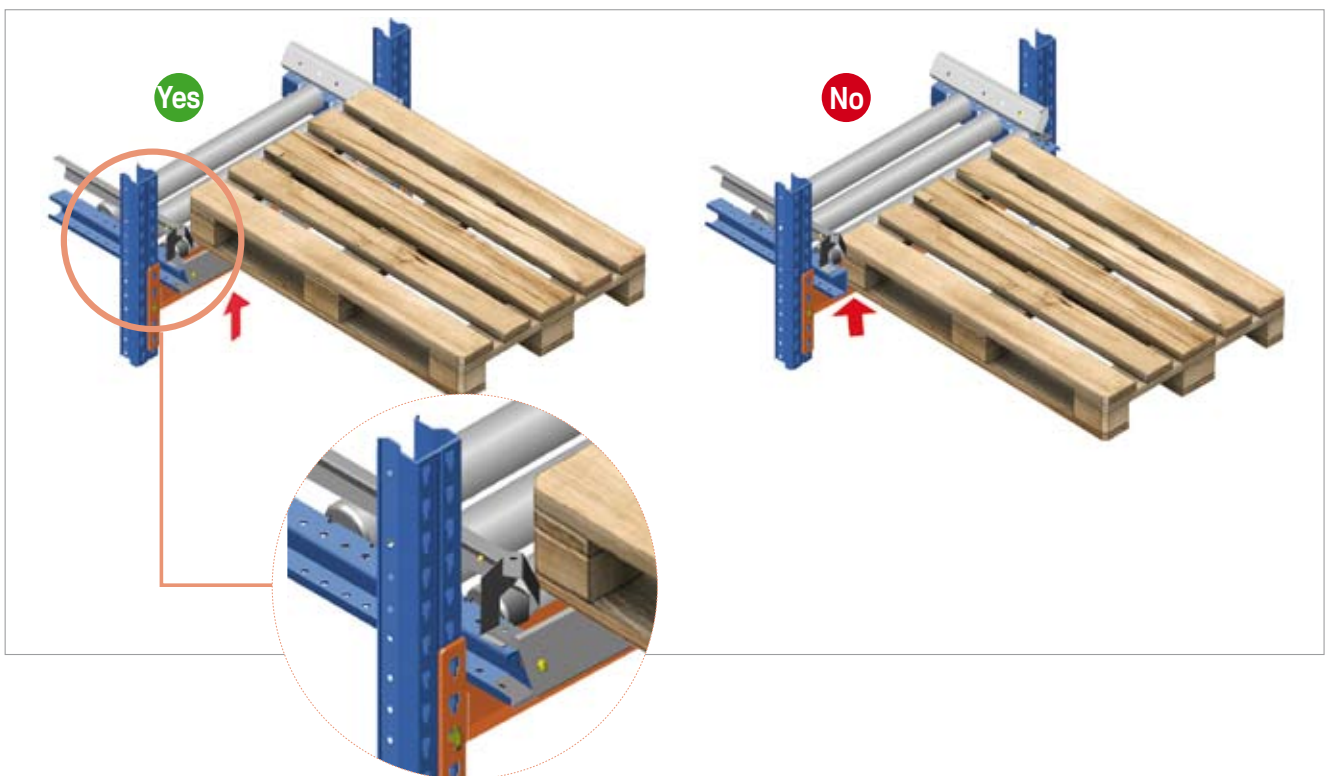

The load must be raised and lowered with the forks centred and in a horizontal position. The operation must take place at the lowest possible speed.

The load unit must never be dragged into the centre position; it must be lowered into place.

The frames and crossbeams, which limit the space where the manoeuvring is done, must always be in sight as well as the load units adjacent to the unit being handled.

## Using the equipment and racking unit

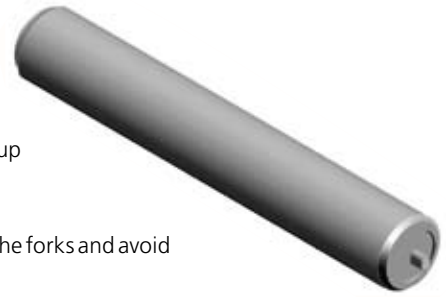

Avoid hitting the rollers. A damaged roller can turn or hold up the pallets.

When removing pallets, they must be properly centred on the forks and avoid hitting the ramps or braking bumpers.

In facilities which use pallet retainers, particularly between the 1st and 2nd pallet, bear in mind that:

- When removing the first pallet, it must not be lifted more than 50 mm to prevent the retainer from unblocking before completely removing the pallet.

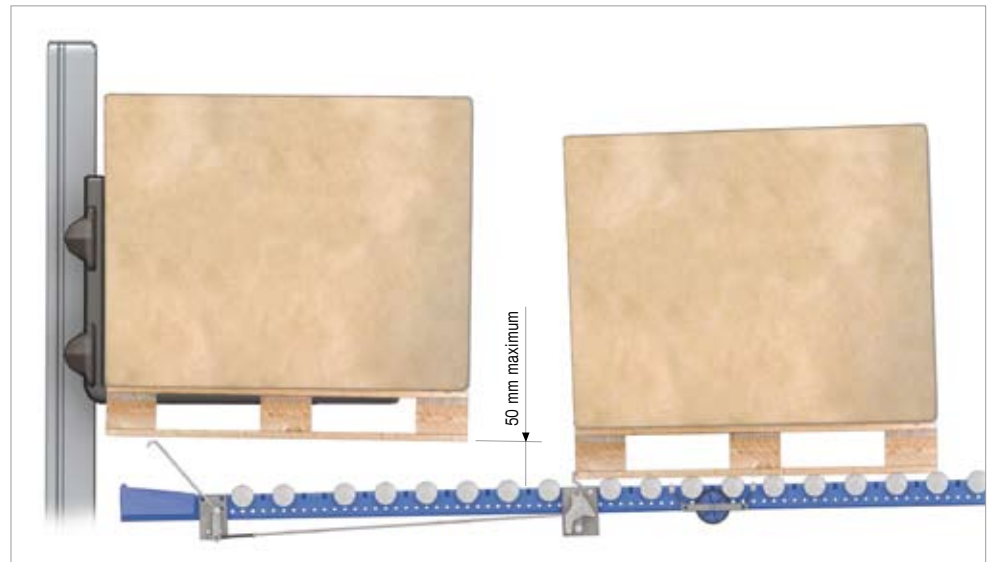

- Never insert pallets into the exit opening.



- Each retainer is valid for only one type of pallet, as indicated on the technical placard. If different pallets are inserted, the retainer will not operate properly and accidents may occur.

### Attention!

Once the pallet has been taken off the roller exit lane, it cannot be put back using this same lane.

Once the pallet has been lifted off the rollers, it must be lifted off completely, it cannot be placed back into the same position.

## Pallet racks for a Push-back system

The factors to bear in mind when using a Push-back storage system include:

### Factor 1. Established design

The established design must not be varied in any shape or form (load units, geometry...) without consulting Mecalux technical departments.

It is expressly prohibited to:

- Modify the height of the levels.
- Modify the number of levels (even when maintaining the load per frame).
- Modify the bars.
- Remove or add levels.
- Use the facility in such a way that damages its principal components (frames, crossbeams, safety catches, braces...).
- Use the facility without its components (frames, crossbeams, safety catches, braces...).
- Use the facility when the frame is out of alignment.

**Important Note!**  
The facility characteristics are reflected on the technical notes from the Mecalux proposal and the load placard placed at the entrance to the facility.

**Factor 2. Placing the load units**

The pallets must always be placed with their bottom skids transversal to the carriages and tracks of the different levels, as well as be in good conditions.



The pallet must always be properly centred.

The pallet must only rest on the two corresponding carriages.



**Factor 3. Abide by clearance margins**

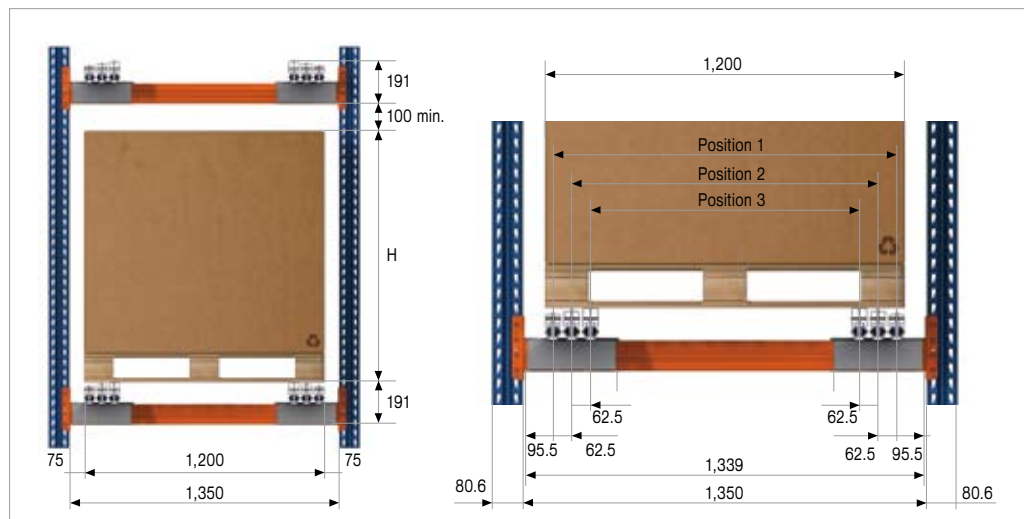

Measurements in mm.

**Factor 4. Loading methods**

The last pallet inserted always rests on the track itself, as each level has one less set of carriages than the number of pallets that can be stored on the level.

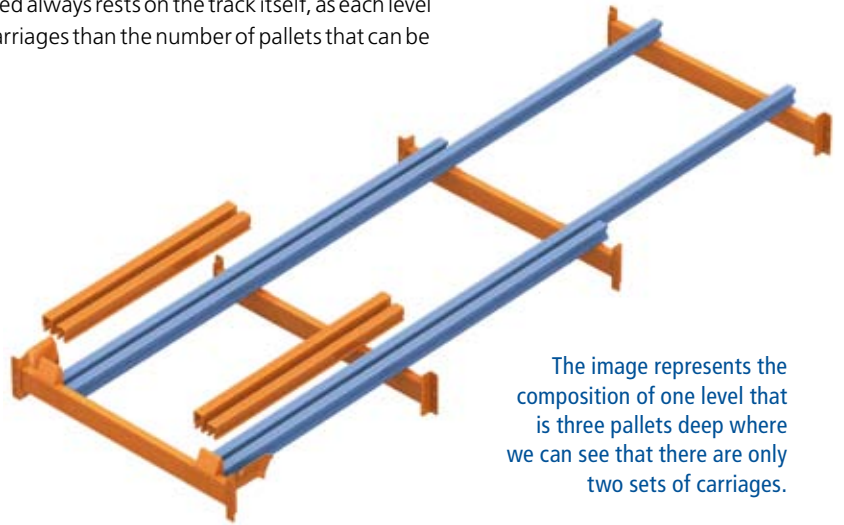

The image represents the composition of one level that is three pallets deep where we can see that there are only two sets of carriages.



**Four-pallet system**

This system has six tracks with three different measurements and six carriages. The first, second and third pallets are stored on the carriages and the fourth directly on the tracks.



---

# Inspection and maintenance

## Inspecting the storage system

### According to EN 15635:

There must always be a person responsible for the storage equipment safety (PRSES).

Racking units and the storage system area must be regularly inspected, and done so specifically when any damage has occurred to either.

A thorough maintenance program is to be executed for the entire facility, with the recommendation that this be carried out by or in accordance with the manufacturer of the racking units. These programs must include the following aspects, among others:

**A)** Upon the establishment of preventive maintenance programs, checklists are to be created to easily and effectively carry out inspections and report any irregularities detected.

**B)** The establishment of a periodic inspection plan to detect, report and record plainly visible irregularities, such as the order and cleanliness of storage and circulation areas, deformed structural components, defects in verticality, weaknesses in the floor, missing safety pins or catches, deteriorated load units, etc., in order to proceed with their immediate repair.

**C)** If the degree of stock rotation and the number of working hours in the warehouse are both quite high, a specific plan of periodic inspections must be established to report any damages, which as a minimum shall entail:

- **Daily sight inspection** carried out by warehouse personnel to detect plainly visible irregularities such as: deformed crossbeams and/or frames, cracks in the floor, absence of levelling shims, broken fasteners, missing safety pins or catches, worn load units, missing signs and placards, damage to the floor or slab, etc. and consequently proceed with their immediate repair or replacement.

- **Weekly inspection** carried out by the person responsible for the warehouse or the person responsible for the storage equipment safety (PRSES), who shall verify the verticality of the structure and all the components on the lower levels (1st and 2nd), properly notifying, qualifying and reporting any damages.

- **Monthly inspection** carried out by the person responsible for the warehouse or the person responsible for the storage equipment safety (PRSES), which also includes the verticality of all levels in the facility and general aspects regarding the order and cleanliness of the warehouse, properly notifying, qualifying and reporting any damages.

- **Annual inspection** carried out by an independent expert who is competent and experienced in this activity. A report shall be delivered notifying, evaluating and communicating damages.

All repairs or modifications which result from the racking unit status reports must be carried out by qualified independent personnel or the manufacturer's own staff with the racks removed of all loads, except if a prior study has been performed on the risks of carrying out repairs with a partial or full load.

After an impact, and according to the resulting damages, any deformed structural component shall be repaired or replaced, verifying the verticality of the racking unit. The new component must be identical to the one replaced and it must never have been submitted to heat (soldering included), as this alters the mechanical performance of steel. In any case, and while the racking unit has not been repaired, it must be unloaded, removed from service, and properly indicated as such.

All potential causes of any form of damage must be investigated so as to reduce or eliminate the possibility of this problem arising and avoid the damage from re-occurring.

Any observation regarding the status of the structures and floor shall be written down in a register stating the date it was observed, the nature of the irregularity detected, any repair work done and the date thereof. It also must include any information related to the loads.

The resulting evaluation of damages or safety issues must constitute the basis for establishing damage prevention measures.

**Immediate warning**

Any damage to the racking units will reduce the resistance and safety coefficients set in the calculation; and for this reason, any damage observed by warehouse personnel in the system must be reported immediately to the person responsible for storage equipment safety (PRSES).

Consequently, all warehouse personnel will receive formal instructions on how to safely operate the system, thus guaranteeing their own safety and that of others.

**Important note on customer/user responsibility in EN 15635:**

The customer/user is responsible for the safety of people and for maintaining the equipment (racking units, stackers, etc) in safe working order.

They are therefore also responsible for ensuring that inspections specified above are performed and that the information stated in the regulation is observed; this includes designating a person to be responsible for the storage equipment safety and preparing a risk prevention plan for the facility.

**Precautions for inspections and incident solving**

The existing hazards when inspecting or working on roller lanes for gravity flow transportation are the following:

- Risk of falling
- Risk of slipping
- Risk of being crushed
- Risk of injuries on sharp edges

Indications given in the working areas must be followed at all times.

Before inspecting the equipment, you must make sure that the lane is blocked.

When inspecting or solving an incident, avoid filling the lane.

Only carry out works using the required personal protection equipment (protective gloves, safety boots, helmet).

Gravity flow roller lanes on racking units must only be accessed using the adequate means. (elevator truck with authorized basket/work lifting platforms).

In the event that pallets remain in the lanes of the racking unit, the inspector or operator must always be behind the pallet (in the same direction as the rollers move).

Pallets should only be pushed, never pulled (for this, some auxiliary elements can be very useful, such as metal levers or pry bars).

Any faults detected in the storage equipment that may entail a danger must be immediately and conveniently repaired. Damaged storage equipment must not be used until fully repaired.

### Maintenance instructions

Once in operation, it is advisable to carry out maintenance tasks at regular intervals, at least every 12 months.

Maintenance must only be carried out by specialized and qualified personnel!

Gravity flow roller units are live systems. This means that all joints with screws must be controlled periodically and repaired whenever necessary.

Brake rollers keep the travelling speed on the live unit constant. The operating speed of a brake roller must never exceed 0.3 m/s, or else it may get damaged. Brake rollers must be checked every 12 months and must be readjusted whenever necessary.

### Checking the frames

Illustrations A, B and C display a few examples of critical deformation.

In order to properly check for structural deformations, a 1-metre rule is placed against the upright, situating its halfway point in the area of greatest deformation, as shown in drawings A and B.

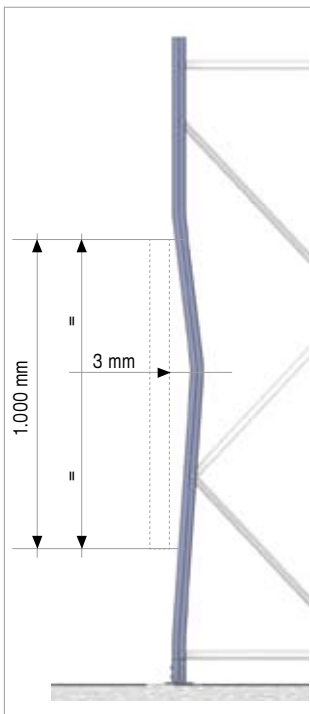

**A)** Uprights bent in the direction of the frame's plane having a permanent deformation equal or greater than 3 mm, as measured from the centre of an interval 1 meter long.

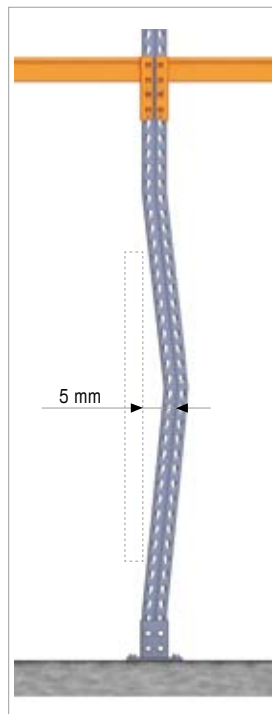

**B)** Uprights bent in the direction of the crossbeam's plane having a permanent deformation equal or greater than 5 mm, as measured from the centre of an interval 1 meter long.

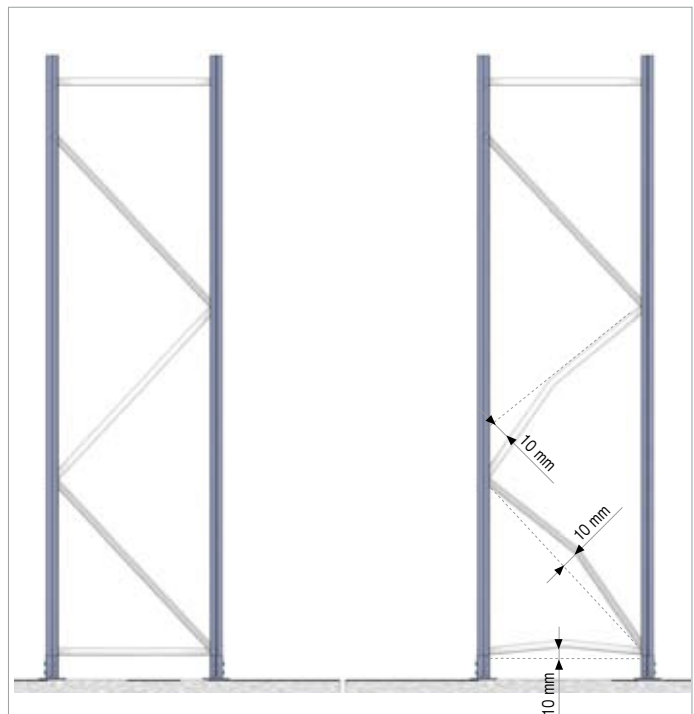

**C)** Permanent deformations equal to or greater than 10 mm in components of the horizontal and diagonal lattice, in any direction. For lengths less than 1 m, the value of 10 mm can be interpolated linearly.

According to convention, bar deformation is classified in green, amber and red status.

**Green:** when deformations are not greater than the previous illustrations. This level only requires monitoring and the facility does not need to lower its storage capacity.

**Amber:** when the deformations are greater than the previous illustration but do not surpass twice this value.

**Red:** A red hazard is considered when the deformations are twice as much as those specified in the previous illustrations, or if there are creases, shearing or dents. The frame is considered out of service whatever the measured distance may be, and thus classified as the highest damage hazard level.

In any case, even when the indicated limits have not been reached, bear in mind the load capacity of the frame has been severely reduced. In the case of doubt, remove the frame from service.



Gouged upright



Dented upright

### Inspecting the racking units

The following flow chart outlines the procedure to follow in the event the racking unit has been damaged.

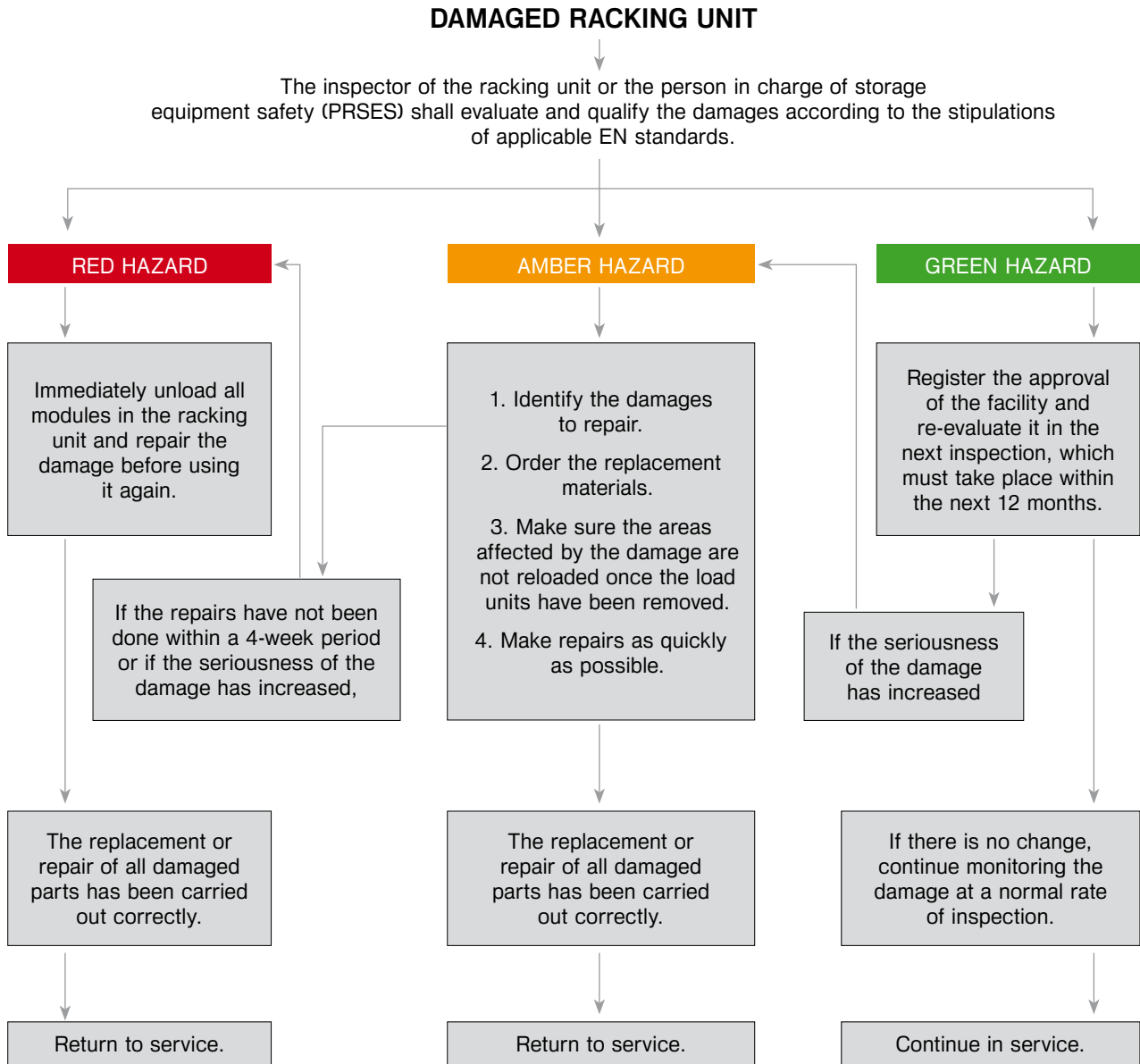

Inspection procedure for classifying damages



### Inspecting the crossbeams

In the following cases, the crossbeam affected must be unloaded and replaced.

- Residual deformation (that which remains after unloading the crossbeam) that is permanent and vertical is greater than 20% of the deformation or nominal distance ( $L/200$ ) with a load.

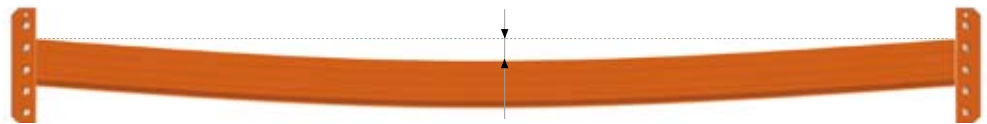

Vertical deformation of a crossbeam

- Residual lateral deformation greater than 50% of the deformation or nominal vertical distance ( $L/200$ ) with a load.

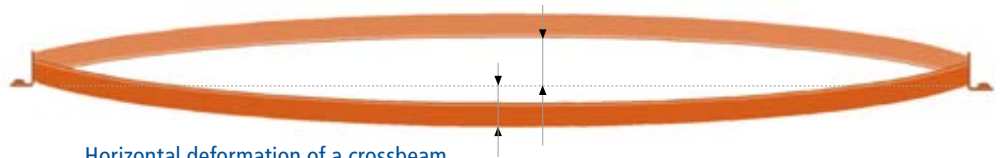

Horizontal deformation of a crossbeam

- The soldered bracket joints are cracked or broken.



- One or more connector tabs are torn off, open or visibly cracked.

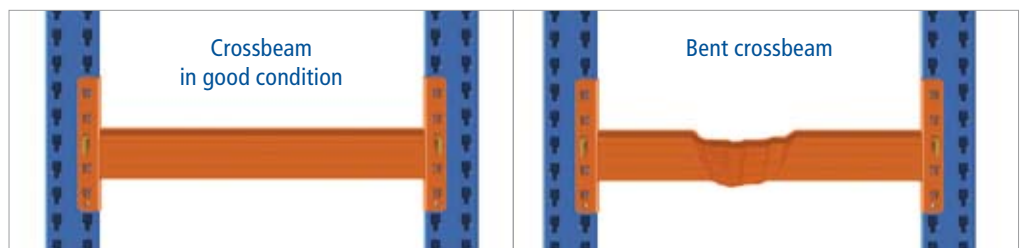

Localized damage in the form of dents, splitting, etc. must be evaluated individually, and in the case of doubt, the level must be unloaded and the damaged crossbeam changed.

### Safety pins and catches

It is essential that all crossbeams have both their safety pins and catches in place to prevent the beam from being accidentally displaced from its housing.

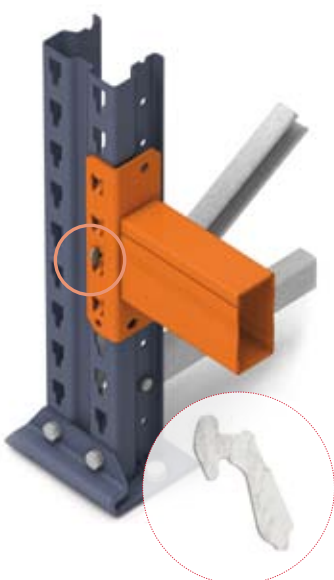

### Rollers

Replacement will be necessary in the following circumstances:

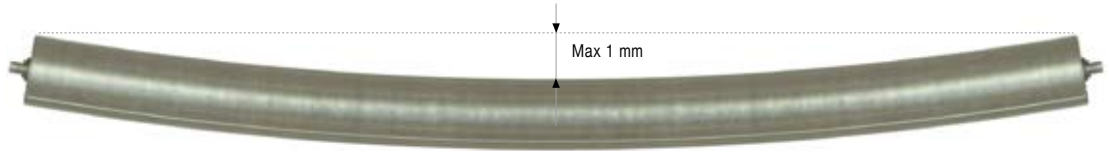

Roller is bent



Roller is dented

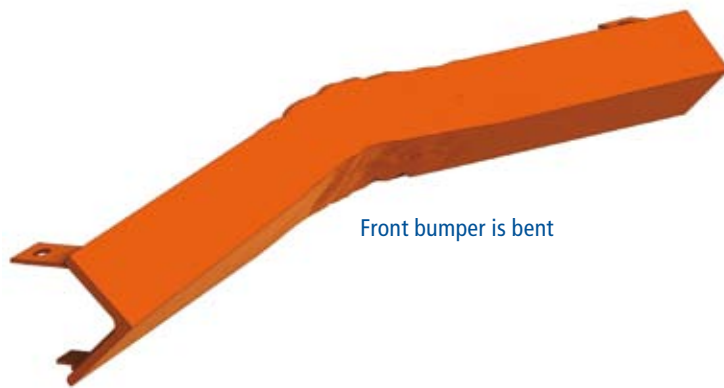

Front bumper is bent



### Carriages

It is essential for the carriage not to have any dents and have all four wheels intact. If not, it must be replaced.

- The damaged components specified above must be replaced.
- The replacement of components will be done according to the structural analysis carried out by the manufacturer.

## Assembly tolerances

The facility must always be within the assembly tolerances in terms of verticality. This ensures that structural elements function properly.

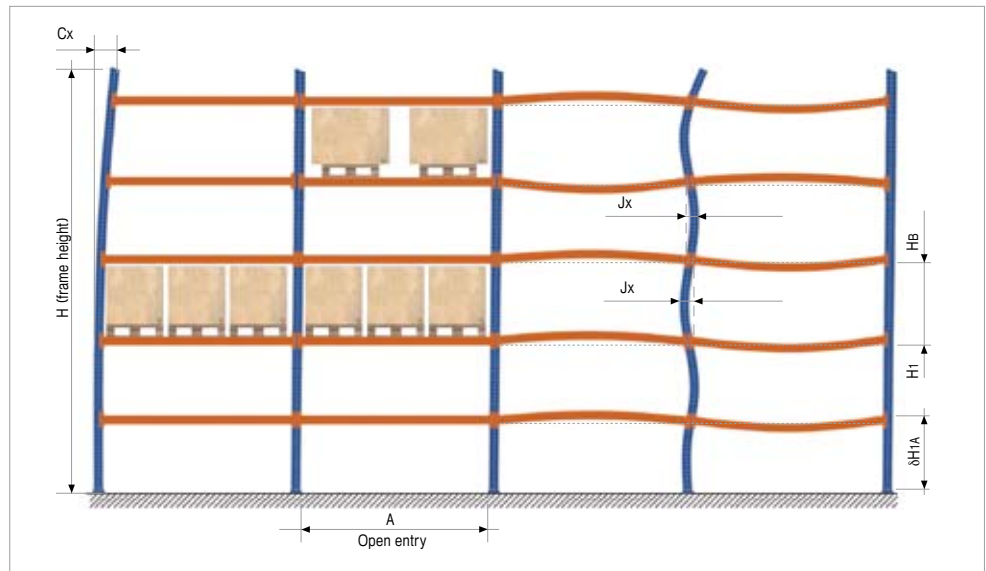

The maximum measurements admissible after assembly must not surpass the following values:

### CLASSES 300 A and B

Cx:  $\pm H/500$

Jx:  $\pm 3\text{mm}$  or  $\pm HB/750$

$\delta H_{1A}$ : the variation in the top of the crossbeam on the lowest level from the floor level at each post  $\pm 7\text{ mm}$

### CLASS 400

Cx:  $\pm H/350$

Jx:  $\pm 3\text{ mm}$  or  $HB/400$  (the highest value of both)

The difference in level between the top part of the front and rear crossbeams within the same void:  $H_y \pm 10\text{ mm}$  (valid for both 300 classes and 400).

In addition to the tolerances previously mentioned for classes 300 and 400, the stipulations mentioned in EN standard 15620 must be complied with.

### Inspecting the floor and aisles

The floor, as a principal component of the facility, must be checked for the following aspects:

**Horizontal alignment:** the floor must respect the horizontal alignment for which the warehouse has been designed. Any irregularities in the floor can be corrected by using metal shims placed below the footplates of the storage system. Make sure the placement of these levelling shims is correct.

The slab must have the proper resistance to bear the pressure transmitted by the frame footplates.

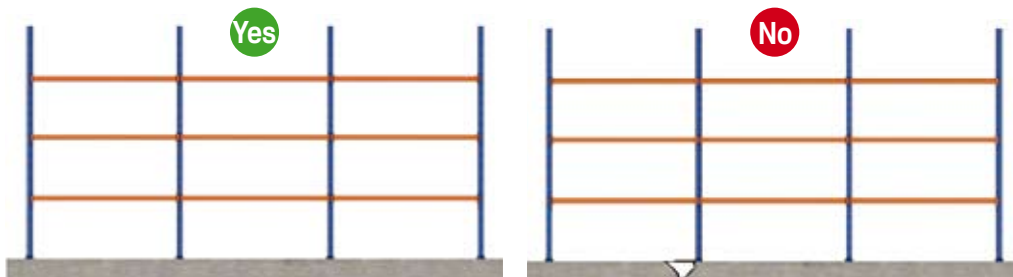

**Resistance:** the floor must not have areas that appear to have sunken, as this may cause the facility to collapse. The floor must have the proper resistance to bear the loads that the storage system transmits to the footplates.

If there areas of the slab begin to sink or shift, the frame verticality may be at risk.

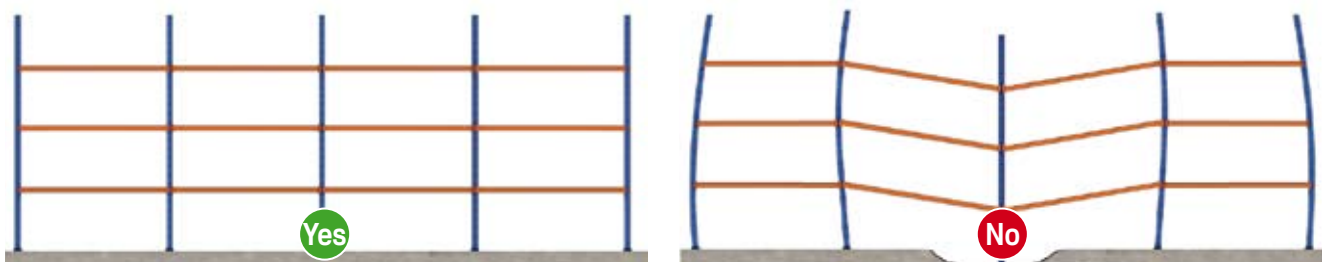

Any irregularities in the floor can be corrected by using levelling shims, which must be perfectly lodged beneath the footplates. An erroneous positioning of these shims will increase the pressure on the slab and even cause the frame to be out of plumb.

**Cleanliness:** all walking and operating aisles and traffic areas must be kept clean and free of obstacles in the aim of creating safe operating conditions. This means avoiding at all costs:

- Placing obstacles in the middle of the aisle so as to minimize the risk of impacting the storage system.
- Oil spots, split liquid or anything else that may cause the lifting equipment to lose their traction or personnel to slip.

## Inspecting the load units

Keep a close eye on the pallets to ensure they are in good conditions, replacing any which are damaged as stipulated in EN standard 15635, annex C.

What's more, a pallet may no longer be used if:

- Its nail heads stick out above the slats.
- The wrong parts have been used (the slats or spacers are too thin, narrow or short).
- The general condition of the pallet is so poor that it cannot handle its load capacity (the slats are rotten or the slats and/or spacers are warped or bent) or there is a risk of dirtying the merchandise.

Skid pallets can no longer be used if, in addition to the previous deficiencies:

- Their slats are broken or missing.
- There is wood missing in the guide skids to such a point where in one slat, two or more nail spikes are visible, or in more than two slats, one or more nail spikes are visible.
- The spacers are missing, broken or warped, or set in such a way that a nail spike is visible.
- Its required marking is absent or illegible.

The previously mentioned indications are also valid for any type of pallet existing on the market today.

- 
- a) Cracks in any of the top slats in along the width or length of its midsection.
  - b) A top slat is broken.
  - c) A top slat is missing.
  - d) Wood is missing on a top slat over more than a third of its width.
  - e) A spacer is missing.
  - f) A spacer(s) is turned more than 30°
  - g) Wood is missing on a top slat between two spacers and in more than ¼ of its width, or when the nails are visible.
  - h) Wood is missing or there are cracks in the spacers in the midsections or at the top of the spacer.
- 

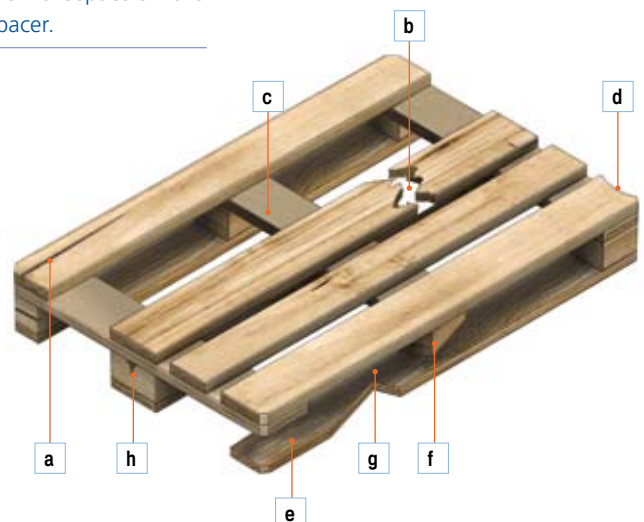



Pallets and containers set aside due to wear shall be kept under control using a system that impedes their return to use in the warehouse.

Make sure that merchandise located on the pallets is kept in good condition, stabilized and strapped down and/or shrink-wrapped.

Make sure that load units do not surpass:

- The maximum nominal weight established for the design and use of the warehouse.
- The maximum nominal dimensions established for the design and use in the warehouse.

Standardised pallets shall adhere to the stipulations in the corresponding regulations:

- **EN 13382**: pallets for handling merchandise. Standard dimensions.
- **EN 13698-1**: specifications for producing pallets. Part 1: specifications for constructing 800x1200 mm flat wooden pallets.
- **EN 13698-2**: specifications for producing pallets. Part 2: specifications for constructing 1000x1200 mm flat wooden pallets.

As an example, take the dimensions of the most common pallet, an 800x1200 mm euro-pallet.

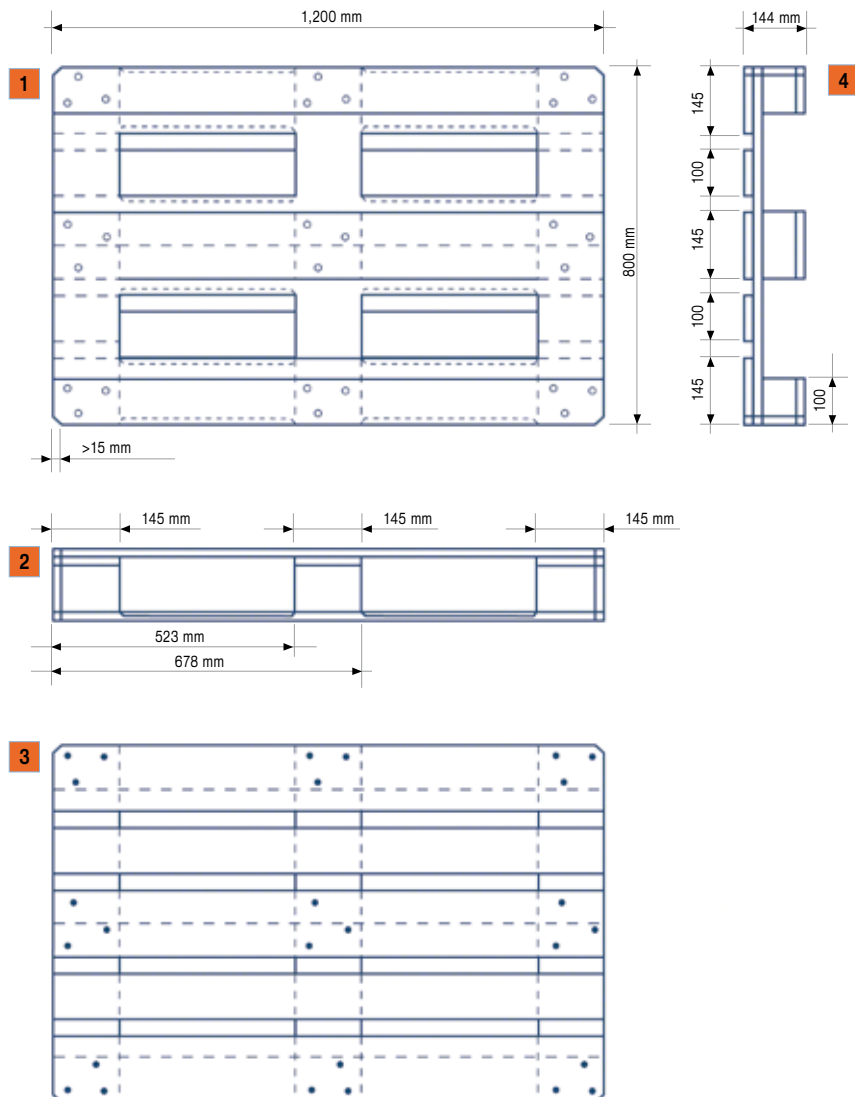

- 1) Bottom view
- 2) Front view
- 3) Topview
- 4) Side view



Checking before operation.

## Inspecting the lifting equipment

### When operating

In this section there is a set of general indications to consider when the lifting equipment being used is a forklift. Nevertheless, facility users must follow the specific indications provided by the manufacturer of these types of machines.

The forklift operator shall inspect the vehicle's main safety mechanism daily, checking the proper condition and operation of:

- the steering system,
- the horn,
- the turning and warning lights,
- reverse gear beeper,
- general brakes and parking brake,
- the driver retention system (safety belt),
- the structural safety equipment,
- the forks and the lifting and tipping systems,
- the condition of the pneumatic system,
- the oil levels and condition of the battery (cleaned and properly connected),
- the access areas are clean,
- the lack of signs or indication which require its immobilisation.



Disabled forklift.

If there are any irregularities, immediately report to the direct superior and stop using the forklift.

If the forklift is not working, take this opportunity to label it with a description of its status.

Smoking is prohibited while operating a forklift or while handling the battery.

### Parking

Once finished operating the forklift, the following instructions must be carried out:

- Park it in the area intended for this purpose. Never do so on a ramp or slope.
- Set the parking brake.
- Put the gears in neutral.
- Lower the forks as far as possible.
- Tip the forks forward.
- Stop the motor.
- Safeguard the forklift against improper use. The starting key must solely be in the possession of its authorized driver, who shall remove it when leaving the vehicle.



Parking.

### Other considerations

- **Paint imperfections.** Make note of any imperfections in the body paint that leave the steel bare, especially in places with aggressive environmental factors.
- **Racking unit related incidents.** Many of the incidents that affect storage systems can create hazardous conditions. This is why it is recommended to immediately contact the manufacturer to make a rapid evaluation of the damage and repair it to re-establish service under the maximum safety conditions.
- The Mecalux Group has a **technical inspection department**, which acts on its own initiative or on prior contact by the customer. It revises those facilities where the high volume of lifting equipment may lead to the greater wear of the structural components, checks they are in proper working conditions, and ensures that the user safety guidelines are being followed. The Mecalux Group provides its customers with warehouse safety manuals so that the operators at their warehouse can use the racking systems appropriately and safely.

## Evaluation checklist for pallet racking live pallet system and Push-back

Date: ...../...../.....

RACK	FRAME N°	IN FRONT	INTERIOR	FRAMES								
				Type: .....			Height..... mm		Lenght ..... mm			
				Uprights		Diagonals in poor condition	Footplate in poor condition	Anchor bolts in poor conditions	Vertical			
Green	Amber	Red	Good	Bad								

RACK	MODULE	LEVEL	IN FRONT	INTERIOR	CROSSBEAMS				OTHER ELEMENTS IN POOR CONDITION								
					Type: ..... Lenght ..... mm				LIVE PALLET								
					Green	Amber	Red	Safety pins missing	Rollers	Tracks	Retainers	Stopper	Brake drums	Brake rollers	Centralizers		

OTHER ELEMENTS IN POOR CONDITION PUSH-BACK	
Carts	Tracks

**COMMENTS**

**HEAD OFFICE - MECALUX, SA**  
**BARCELONA** - Tel. + 34932 616 913  
Silici, 1  
08940 Cornellà de Llobregat  
(SPAIN)  
Fax + 34 932 632 682

**MECALUX UK Ltd.**  
**BIRMINGHAM** - Tel. 0121 3336 602  
Unit 9, Network Park  
Mill Road, Saltley  
Duddeston, Birmingham B8 1AU  
Fax 0121 3335 622

## MECALUX HAS A PRESENCE IN MORE THAN 70 COUNTRIES WORLDWIDE

Offices in: Argentina - Belgium - Brazil - Canada - Chile - Czech Republic - France - Germany - Italy - Mexico - Netherlands  
Panama - Peru - Poland - Portugal - Slovakia - Spain - Turkey - United Kingdom - Uruguay - USA



e-mail: [info@mecalux.com](mailto:info@mecalux.com) - [www.mecalux.com](http://www.mecalux.com)

Mecalux offers to all its customers a special technical inspection service carried out on completion of installation, as well as for advice in case of changes, damages to the racking or alterations.

In the event of any accident at the installation, please notify our technical inspection department immediately for a quick and proper inspection and/or repair to be made.

In this way we hope to continue making strides towards our ongoing quality control goals which we have been building on for years to offer our customer better and better service.

